

Series **TT01**

DIGITAL CAP TORQUE TESTERS

User's Guide

MARK-10®

Thank you...



Thank you for purchasing a Mark-10 Series TT01 digital cap torque tester, designed to measure bottle cap application and removal torque.

With proper usage, we are confident that you will get many years of great service with this product. Mark-10 instruments are ruggedly built for both laboratory and industrial environments.

This User's Guide provides setup, safety, and operation instructions. Dimensions and specifications are also provided. For additional information or answers to your questions, please do not hesitate to contact us. Our technical support and engineering teams are eager to assist you.

Before use, each person who is to use a Series TT01 digital cap torque tester should be fully trained in appropriate operation and safety procedures.

TABLE OF CONTENTS

OVERVIEW.....	2
POWER.....	3
SETUP	4
HOME SCREEN AND CONTROL.....	5
OPERATING MODES.....	7
CHANGING THE UNITS.....	7
DIGITAL FILTERS.....	7
SET POINTS.....	8
BREAK DETECTION.....	9
FIRST / SECOND PEAK	11
DATA MEMORY AND STATISTICS	13
COMMUNICATIONS AND OUTPUTS	15
CALIBRATION	19
PASSWORDS.....	23
OTHER SETTINGS.....	24
SPECIFICATIONS	27

1 OVERVIEW

1.1 List of included items

Qty.	Part No.	Description
1	MTT01-12 / MTT01-25 / MTT01-50 / MTT01-100	Series TT01 digital cap torque tester
1	CT004	Sample gripping posts, 4
1	AC1118	Battery (inside the instrument)
1	-	Certificate of calibration
1	AC1111	USB cable
-	USB driver, MESUR® Lite software, MESUR®gauge evaluation software, User's Guide Download at: www.mark-10.com/resources	
Optional Items		
1	CT001	Flat jaws set, 2
1	CT002	Carrying case
1	CT003	Adjustable jaws set, 2
1	CT005	Set of 2.5" sample gripping posts, 4
1	CT006	Set of 4" sample gripping posts, 4
1	CT007	Kit of sample gripping posts, 12

1.2 Safety / Proper Usage

Caution!

Note the torque tester's capacity before use and ensure that the capacity is not exceeded. Producing a torque greater than 150% of the tester's capacity can damage the internal sensor. An overload can occur whether the tester is powered on or off.

The tester is designed primarily for the testing of threaded bottle caps, although other items can be tested as well. Items that should not be used with the tester include potentially flammable substances or products, items that can shatter in an unsafe manner, and any other components that can present an exceedingly hazardous situation when acted upon by a load.

The following safety checks and procedures should be performed before and during operation:

1. Never operate the tester if there is any visible damage to the AC adapter or the tester itself.
2. Ensure that the tester is kept away from water or any other electrically conductive liquids at all times.
3. The tester should be serviced by a trained technician only. AC power must be disconnected and the tester must be powered off before the housing is opened.
4. Always consider the characteristics of the sample being tested before initiating a test. A risk assessment should be carried out beforehand to ensure that all safety measures have been addressed and implemented.
5. Wear eye and face protection when testing, especially when testing brittle samples that have the potential to shatter under force. Be aware of the dangers posed by potential energy that can accumulate in the sample during testing. Extra bodily protection should be worn if a destructive failure of a test sample is possible.
6. In certain applications, such as the testing of brittle samples that can shatter, or other applications that could lead to a hazardous situation, it is strongly recommended that a machine guarding

system be employed to protect the operator and others in the vicinity from shards or debris.

7. When the tester is not in use, ensure that the power is turned off.

2 POWER

The TT01 is powered either by an 8.4V NiMH rechargeable battery or by an AC adapter. Since these batteries are subject to self discharge, it may be necessary to recharge the unit after a prolonged period of storage. Plug the accompanying charger into the AC outlet and insert the charger plug into the receptacle on the tester (refer to the illustration below). The battery will fully charge in approximately 8 hours.

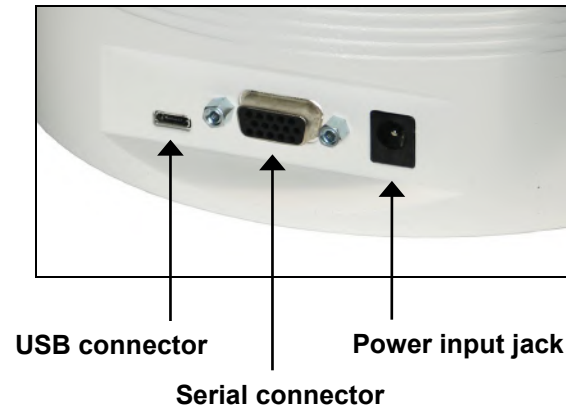





Caution!

Do not use chargers or batteries other than supplied or instrument damage may occur.

If the AC adapter is plugged in, an icon appears in the lower left corner of the display, as follows: 

If the AC adapter is not plugged in, battery power drainage is denoted in a five-step process:

1. When battery life is greater than 75%, the following indicator is present: 
2. When battery life is between 50% and 75%, the following indicator is present: 
3. When battery life is between 25% and 50%, the following indicator is present: 
4. When battery life is less than 25%, the following indicator is present: 
5. When battery life drops to approximately 2%, the indicator from step 4 will be flashing. Several minutes after (timing depends on usage and whether the backlight is turned on or off), a message appears, "BATTERY VOLTAGE TOO LOW. POWERING OFF". A 4-tone audio indicator will sound and the tester will power off.

The tester can be configured to automatically power off following a period of inactivity. Refer to the **Other Settings** section for details.

If battery replacement is necessary, the battery may be accessed by removing the cover attached to the underside of the base.

3 SETUP

3.1 Mechanical Setup

Place the sample between the posts or jaws of the tester, and tighten, using the knob. Always ensure that the sample is gripped firmly, however, excessive tightening of thin-walled closures may result in sample deformation, possibly affecting test results. When the sample is secured, gradually exert torque on the bottle cap by hand.

3.1.1 Sample gripping methods

Three different sample gripping methods are available, as shown below:



Posts (included)



Flat jaws (optional)



Adjustable jaws (optional)

3.1.2 Proper alignment

The center of the bottle cap should be positioned axially with respect to the center of the loading table. Side loading or off-center loading may produce erroneous readings, and can damage the instrument.

3.1.3 Mounting to a bench

The tester can be mounted to a bench using the four threaded holes on the underside of the base.

3.2 Installing the USB driver

If communicating via USB, install the USB driver available at: www.mark-10.com/resources

Caution!

Install the USB driver before physically connecting the tester to a PC with the USB cable.



Further instructions for configuring and using the tester's outputs are provided in the **Communications and Outputs** section.

4 HOME SCREEN AND CONTROL

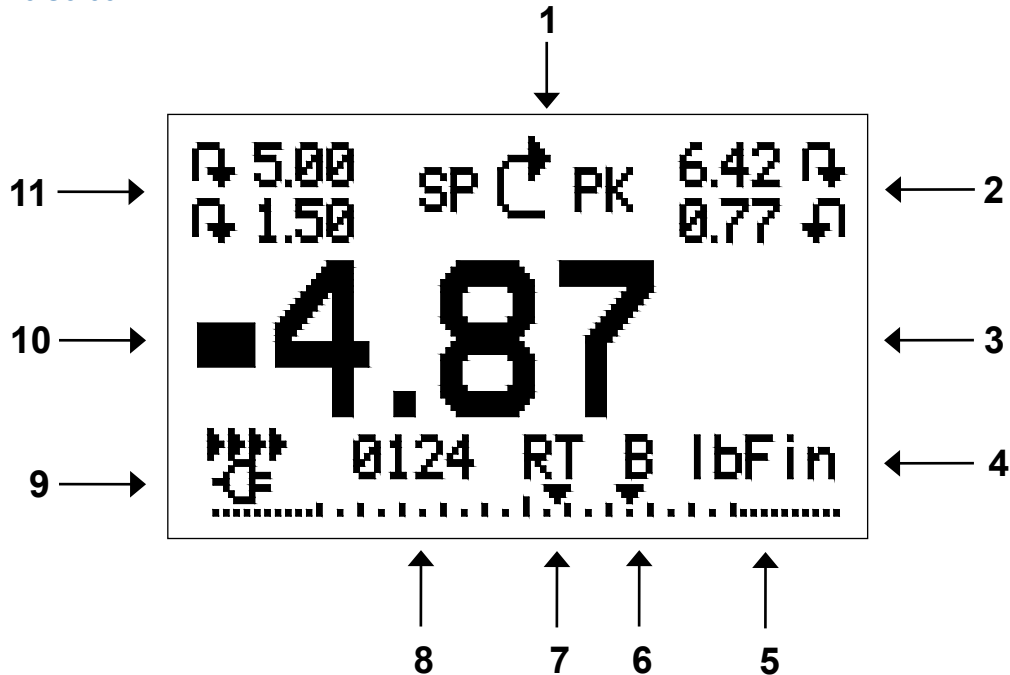

4.1 Home Screen



No.	Name	Description
1	Measurement direction indicator	↻ – indicates clockwise direction ↺ – indicates counter-clockwise direction These indicators are used throughout the display and menu.
2	Peaks	The maximum measured clockwise and counter-clockwise readings. These readings are reset by pressing ZERO or by powering the tester off and on.
3	Primary reading	The current displayed load reading. See Operating Modes section for details.
4	Units	The current measurement unit. Abbreviations are as follows: ozFin – Ounce-inch lbFin – Pound-inch kgFcm – Kilogram-centimeter Ncm – Newton-centimeter Nm – Newton-meter
5	Load bar	Analog indicator to identify when an overload condition is imminent. The bar increases either to the right or left from the midpoint of the graph. Increasing to the right indicates clockwise load, increasing to the left indicates counter-clockwise load. If set points are enabled, triangular markers are displayed for visual convenience. This indicator reflects the actual load, which may not correspond to the primary reading (depends on operating mode). The ZERO key does not reset the load bar. See Operating Modes section for details.
6	Break Detection On/Off	The letter "B" appears if the Break Detection function is enabled. Refer to the Break Detection section for details.
7	Mode	The current measurement mode. Abbreviations are as follows: RT – Real Time PCW – Peak Clockwise PCCW – Peak Counter-clockwise See Operating Modes section for details about each of these modes
8	Number of stored	The number of stored data points in memory, up to 1000. Displayed only if

	data points	Memory Storage is enabled for the DATA key.
9	Battery / AC adapter indicator	Either the AC adapter icon or battery power icon will be shown, depending on power conditions. Refer to the Power section for details.
10	High / low limit indicators	Correspond to the programmed set points. Indicator definitions are as follows:  – the primary reading is greater than the upper load limit  – the primary reading is between the load limits  – the primary reading is less than the lower load limit
11	Set points	The programmed load limit values. Typically used for pass/fail type testing. One, two, or no indicators may be present, depending on the configuration shown in the Set Points menu item.

4.2 Controls

Primary Label	Primary Function	Secondary Label	Secondary Function
	Powers the tester on and off. Press briefly to power on, press and hold to power off. Active only when the home screen is displayed.	ENTER	Various uses, as described in the following sections.
ZERO	Zeroes the primary reading and peaks.	 (UP)	Navigates up through the menu and sub-menus.
MENU	Accesses the main menu.	ESCAPE	Reverts one step backwards through the menu hierarchy.
MODE	Toggles between measurement modes.	 (DOWN)	Navigates down through the menu and sub-menus.
DATA	Stores a value to memory and/or transmits the current reading to an external device, depending on configuration.	DIRECTION	Toggles between clockwise and counter-clockwise directions while configuring set points and other menu functions.

Note: Measurement units are configured through the menu. Refer to the **Changing The Units** section for details.

4.3 Menu navigation basics

Most of the tester's various functions and parameters are configured through the main menu. To access the menu press **MENU**. Use the **UP** and **DOWN** keys to scroll through the items. The current selection is denoted with clear text over a dark background. Press **ENTER** to select a menu item, then use **UP** and **DOWN** again to scroll through the sub-menus. Press **ENTER** again to select the sub-menu item.

For parameters that may be either selected or deselected, press **ENTER** to toggle between selecting and deselecting. An asterisk (*) to the left of the parameter label is used to indicate when the parameter has been selected.

For parameters requiring the input of a numerical value, use the **UP** and **DOWN** keys to increment or decrement the value. Press and hold either key to auto-increment at a gradually increasing rate. When the desired value has been reached, press **ENTER** to save the change and revert back to the sub-menu item, or press **ESCAPE** to revert back to the sub-menu item without saving. Press **ESCAPE** to revert one step back in the menu hierarchy until back into normal operating mode.

Refer to the following sections for details about setting up particular functions and parameters.

5 OPERATING MODES

Caution!

In any operating mode, if the capacity of the instrument has been exceeded by more than 110%, the display will show “OVER” to indicate an overload. A continuous audible tone will be sounded (if tones are enabled) until the MENU key has been pressed or the load has been reduced to a safe level.

Three operating modes are possible with the TT01 torque tester. To cycle between the modes, press **MODE** while in the home screen.

5.1 Real time (RT)

The primary reading corresponds to the live measured reading.

5.2 Peak Clockwise (PCW)

The primary reading corresponds to the peak clockwise reading observed. If the actual load decreases from the peak value, the peak will still be retained in the primary reading area of the display. Pressing **ZERO** will reset the value.

5.3 Peak Counter-clockwise (PCCW)

Same as above, but for counter-clockwise readings.

6 CHANGING THE UNITS

The TT01 can display five different measurement units. To change the unit, select **Units** from the menu. The display will list the available units, as follows:

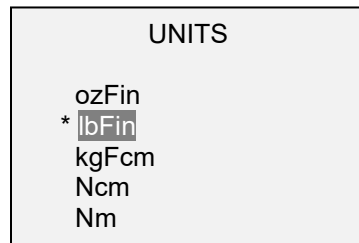

The tester will always power on with the unit selected in this sub-menu.

7 DIGITAL FILTERS

Digital filters are provided to help smooth out the readings in situations where there is mechanical interference in the work area or test sample. These filters utilize the moving average technique in which consecutive readings are pushed through a buffer and the displayed reading is the average of the buffer contents. By varying the length of the buffer, a variable smoothing effect can be achieved. The selection of 1 will disable the filter since the average of a single value is the value itself.

To access digital filter settings, select **Filters** from the menu. The display appears as follows:

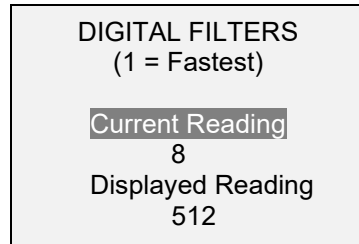

Two filters are available:

Current Reading – Applies to the peak capture rate of the instrument.

Displayed Reading – Applies to the primary reading on the display.

Available settings: 1,2,4,8,16,32,64,128,256,512,1024. It is recommended to keep the current reading filter at its lowest value for best performance, and the displayed reading filter at its highest value for best stability.

8 SET POINTS

8.1 General Information

Set points are useful for tolerance checking (pass/fail) and triggering an external device in process control applications. Two limits, high and low, are programmed in the tester, and the primary reading is compared to these limits. The results of the comparisons are indicated via on-screen indicators as well as through the three outputs provided on the 15-pin connector, thus providing “under”, “in range”, and “over” signaling. These outputs can be connected to indicators, buzzers, or relays as required for the application. On-screen indicators are described in the next sub-section.

8.2 Configuration

To configure set points, select **Set Points** from the menu. The display appears as follows:

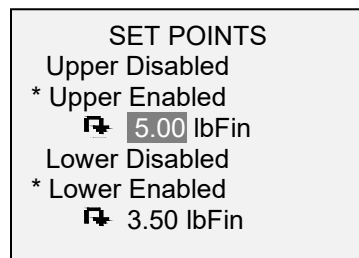

Either one, two, or none of the set points may be enabled. To toggle between the clockwise and counter-clockwise directions, press the **DIRECTION** key.

If two set points have been enabled, they are displayed in the upper left corner of the display. If only one set point has been enabled, the word “OFF” appears in place of the value. If no set points have been enabled, the upper left corner of the display will be blank.

When set points are enabled, the following indicators are shown to the left of the primary reading:

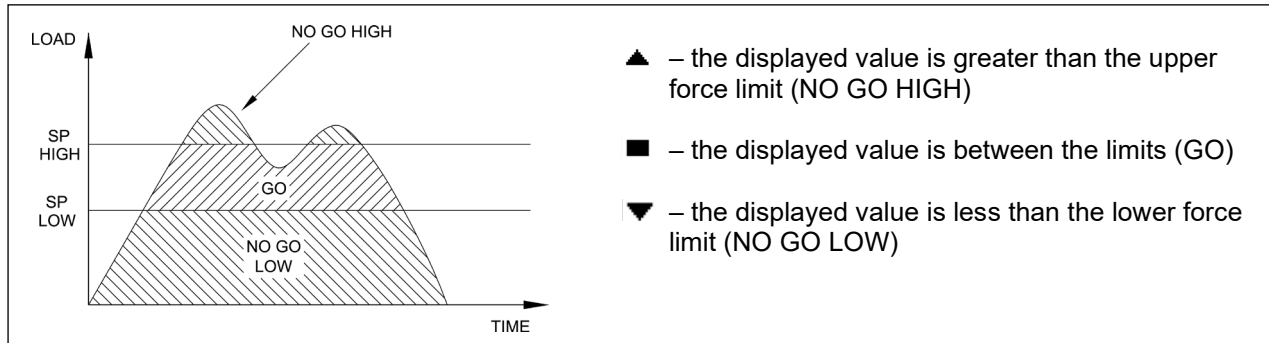

Note: Set point indicators reference the displayed reading, not necessarily the current live load.

8.2.1 Set Point Outputs Schematic Diagram

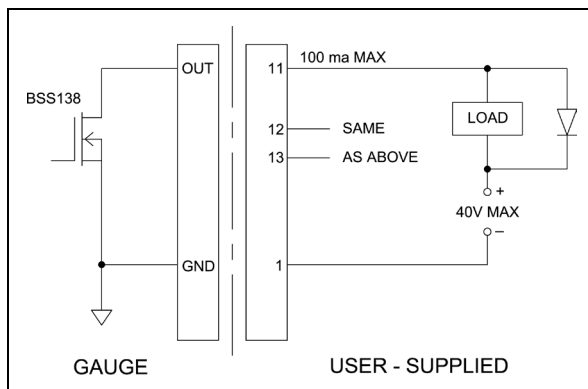

9 BREAK DETECTION

The break detection function identifies when the cap has been loosened, or other applications in which the torque value has reached a peak, then dropped. Upon detection of the break, the tester can perform several automatic functions, as follows:

1. Transmit the peak reading (Auto Output).
2. Save the peak value to memory (Auto Storage).
3. Zero the primary and peak readings (Auto Zero).
4. Toggle a pin.

Break detection functions and settings are configured from a central location, and apply to any mode in which it is enabled. Refer to the **Operating Modes** section for details on configuring each mode.

9.1 Configuration

To enable Break Detection and configure the automatic functions, select **Break Detection** from the main menu. The display appears as follows:

<p>BREAK DETECTION</p> <p>Enabled</p> <p>+ Break Settings</p> <p>+ Auto Output</p> <p>Auto Storage</p> <p>Auto Zero</p>

Any combination of the above functions may be selected.

Function	Description
Enabled	Arms the break detection function. When enabled, the letter "B" will appear on the home screen, between the Mode and Unit indicators. Refer to the Home Screen and Controls section for details. Note: Break Detection and First / Second Peak mode cannot be enabled simultaneously.
Break Settings	Refer to the following sub-sections for details.
Auto Output	
Auto Storage	
Auto Zero	Automatically zeroes the display following data transmission and/or storage. A time delay may be configured in Break Detection Settings . Refer to the next sub-section for details.

If tones are enabled, a tone will sound when the output, storage, and zero functions have occurred.

9.2 Break Settings

Select **Break Settings** from the **Break Detection** menu to configure the settings. The display appears as follows:

<p>BREAK DETECTION SETTINGS</p> <p>Threshold: 5 %</p> <p>% Drop: 50 %</p> <p>Auto Zero Delay 5 sec.</p>

Threshold	Sets the percentage of full scale at which the break detection function becomes active. This threshold is provided to ignore peaks that can occur during sample loading and unloading. <i>Available settings: 1–90%, in 1% increments until 5%, 5% increments thereafter.</i>
% Drop	Sets the percentage drop from the peak reading at which the break is detected. <i>Available settings: 5%–90% in 5% increments.</i>
Auto Zero Delay	Sets the time delay before the primary and peak readings are zeroed. Auto zero can be disabled if required. Refer to the Auto Output Settings sub-section for details. <i>Available settings: 1–10 sec. in 1 sec. increments, and 10–60 sec. in 5 sec. increments.</i>

9.3 Auto Output Settings

Scroll to **Auto Settings** in the **Break Detection** menu and press **ENTER** to configure the auto output settings. Any combination may be selected. The display appears as follows:



Parameter	Description
RS232/USB Output	Automatically output the peak when the break (% Drop) is detected.
Mitutoyo Output	Automatically output the peak when the break (% Drop) is detected.
Output Pin	Automatically toggle the SP1, SP2, or SP3 pins (active low). If not required, select "NONE".

10 FIRST / SECOND PEAK

This function captures two consecutive peaks which can occur over the course of a test, such as with tamper evident breakaway band closures. See illustration below:

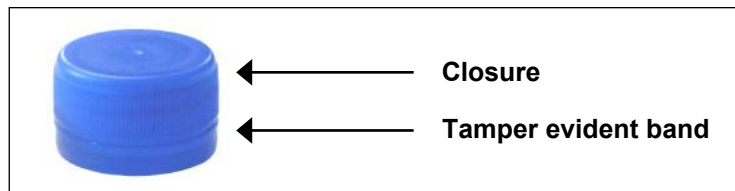

Peak torque measurements occur as follows:

1. Torque at which the closure slips from the neck of the bottle
2. Torque at which the cap breaks away from the band

10.1 Configuration

Several functions can be triggered automatically upon first and second peaks:

1. Transmit the first peak reading
2. Transmit the second peak reading
3. Save the first peak value to memory
4. Save the second peak value to memory
5. Zero the primary and peak readings

These automatic functions can help automate and expedite testing processes. If tones are enabled, an audible tone will sound when the output, storage, and zero functions have occurred. In order for First / Second Peak detection to be active, the appropriate operating mode must be selected. See the **Operating Modes** section for details. The display appears as follows:

FIRST/SECOND PEAK
* Enabled
+ Peak Settings
+ Auto Output
* Auto Store PK1
Auto Store PK2
* Auto Zero

Any combination of the above functions may be selected.

Function	Description
Enabled	If enabled, 2PK appears as one of the operating modes. In the main display, the Peak readings will reference the first and second peaks – first peak on top, second peak below. Refer to the Home Screen & Control section for details.
Peak Settings	Press ENTER to access the Peak Settings sub-menu. See the following sections for details.
Auto Output	Press ENTER to access the Auto Output Settings sub-menu. See the following sections for details.
Auto Store PK1	Automatically stores the first peak reading to memory.
Auto Store PK2	Automatically stores the second peak reading to memory.
Auto Zero	Automatically zeroes the display following data transmission and/or storage.

10.2 Settings

The display appears as follows:

PEAK SETTINGS
Thresh. 1: 5 %
% Drop 1: 10 %
Thresh. 2: 5 %
% Drop 2: 10 %
Auto Zero Delay
3 sec.

Threshold 1	Sets the percentage of full scale at which the first/second peak detection feature becomes active. This threshold is provided to ignore peaks that can occur during sample loading and unloading. Available settings: 1-90%, in 1% increments between 1-5%, and in 5% increments between 5-90%.
Percentage Drop 1	Identifies the first peak via detection of a specified percentage drop from peak.
Threshold 2	Same as Threshold 1, but refers to a percentage increase above the load associated with the first peak percentage drop.
Percentage Drop 2	Same as Percentage Drop 1, for the second peak.
Auto Zero Delay	Sets the time delay before the primary and peak readings are zeroed. Available settings: 1-60 sec., in 1 sec. increments between 1-5 sec., and in 5 sec. increments between 5-60 sec.

Thresholds and percentage drops are illustrated below:

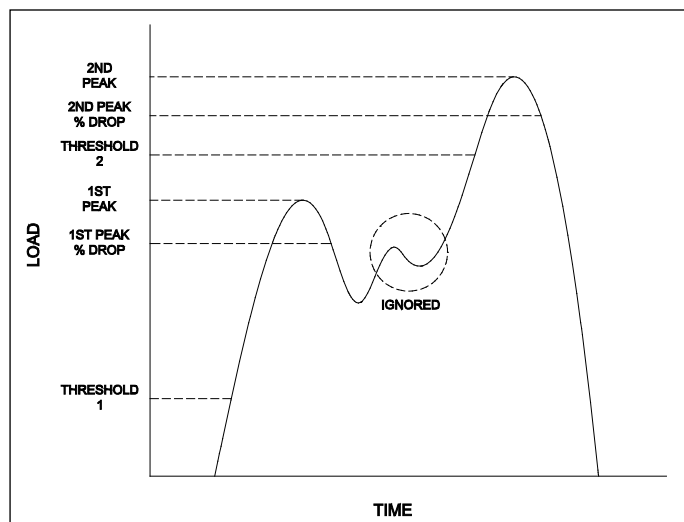

10.3 Auto Output Settings

Select the output type. Select RS-232/USB and/or Mitutoyo outputs, and select First and/or Second peaks. The display appears as follows:



11 DATA MEMORY AND STATISTICS

Series TT01 testers have storage capacity of 1,000 data points. Readings may be stored, viewed, and output to an external device. Individual, or all, data points may be deleted. Statistics are calculated for the data presently in memory.

Individual data points may be saved to memory by pressing the **DATA** key, or automatically via the **Break Detection** function, whichever is enabled. Refer to the **Communications** section for details. Once data storage has been enabled, the data record number **0000** appears below the primary reading in the home screen. The record number will increment each time **DATA** is pressed or the automatic data storage function is activated. When memory is full the message "MEMORY FULL" will be flashed at the bottom of the display and a double audio tone will be sounded.

To view, edit, and output stored readings and statistics, select **Memory** from the menu. The display appears as follows:

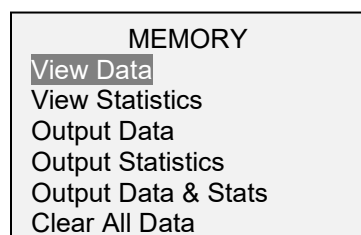

11.1 View Data

All the saved data points may be viewed. The record number is displayed, along with the corresponding value and presently set unit of measurement. Any readings may be deleted individually. To do so, scroll to the desired reading and press **DELETE**. The letter “D” appears to the left of the record number, indicating that the tester is in **Delete** mode, as follows:

0001	2.458 lbFin
0002	2.224 lbFin
0003	2.446 lbFin
0004	1.890 lbFin
D 0005	2.098 lbFin
0006	1.998 lbFin
0007	2.042 lbFin

Press **ENTER** to delete the value. To exit **Delete** mode, press **DELETE** again. Any number of readings may be individually deleted, however, all readings may also be cleared simultaneously. Refer to the **Clear All Data** sub-section for details.

11.2 Statistics

Statistical calculations are performed for the saved values. Calculations include number of readings, minimum, maximum, mean, and standard deviation.

11.3 Output Data

Press **ENTER** to output data to an external device. The display will show, “SENDING DATA...”, then “DATA SENT”. If there was a problem with communication, the display will show, “DATA NOT SENT”. Saved data can be downloaded by some Mark-10 data collection programs. Refer to their respective user's guides for details.

11.4 Output Statistics

Press **ENTER** to output statistics to an external device. The display will show, “SENDING STATS...”, then “STATS SENT”. If there was a problem with communication, the display will show, “STATS NOT SENT”.

11.5 Output Data & Stats

Press **ENTER** to output data and statistics to an external device. The display will show, “SENDING DATA”, then “SENDING STATS...”, then “DATA SENT”, then “STATS SENT”. If there was a problem with communication, the display will show, “DATA NOT SENT” and/or “STATS NOT SENT”.

11.6 Clear All Data

Press **ENTER** to clear all data from the memory. A prompt will be shown, “CLEAR ALL DATA?”. Select **Yes** to clear all the data, or **No** to return to the sub-menu.

For output of data and/or statistics, RS-232 or USB output must be enabled. Data formatting is <CR><LF> following each value. Units can be either included or excluded. Output of data via the Mitutoyo output is possible, however, output of statistics is not. Refer to the **Communications** section for details.

Note: Data is not retained while the tester is powered off. However, the tester protects against accidental or automatic power-off. If manually powering the instrument off, or if the inactivity time limit for the **Automatic Shutoff** function has been reached, the following warning message appears:



If no option is selected, this screen will be displayed indefinitely, or until battery power has been depleted.

12 COMMUNICATIONS AND OUTPUTS

Communication with the TT01 tester is achieved through the micro USB or 15-pin serial ports located in the rear of the housing, as shown in the illustration in the **Power** section. Communication is possible only when the tester is in the main operating screen (i.e. not in a menu or configuration area).

12.1 Serial / USB

To set up RS-232 and USB communication, select **Serial/USB Settings** from the menu. The display appears as follows:

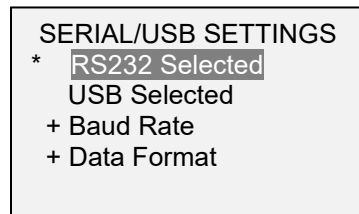

Select either RS-232 or USB input (output is always simultaneous through both the USB and RS-232 ports). Communication settings are permanently set to the following:

Data Bits: 8
Stop Bits: 1
Parity: None

Other settings are configured as follows:

12.1.1 Baud Rate

Select the baud rate as required for the application. It must be set to the same value as the receiving device.

12.1.2 Data Format

Select the desired data format. The display appears as follows:

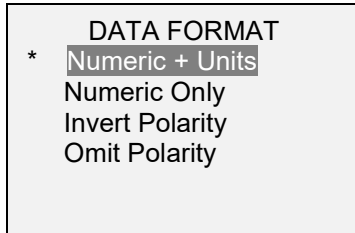

Selection	Description
Numeric + Units	Output format includes the value and unit of measure. Clockwise values have positive polarity, counter-clockwise values have negative polarity.
Numeric Only	Output format includes the value only. Polarity same as above.
Invert Polarity	Clockwise values have negative polarity, counter-clockwise values have positive polarity. May be selected in addition to the Numeric + Units / Numeric Only selection.
Omit Polarity	Both directions are formatted with positive polarity. May be selected in addition to the Numeric + Units / Numeric Only selection.

12.1.3 Data Communication

Individual data points may be transmitted by pressing **DATA**. Series TT01 testers may also be controlled by an external device through the RS-232 or USB channels. The following is a list of supported commands and their explanations. All commands must be terminated by a CR (Carriage Return) character, 0x0D, or a CR-LF (Carriage Return – Line Feed) pair, where the Line Feed, 0x0A, is ignored.

?	Request the displayed reading
MEM	Transmit all stored readings
STA	Transmit statistics
CLRMEM	Delete all stored readings from memory

12.1.4 Command Responses

In response to the reading request command '?' the tester will return a string with the load data, followed by a space, then the load unit (if enabled under the **Serial/USB Settings** → **Data format** sub-menu). It will be terminated by a CR-LF pair.

Example return strings:

```
-18.78 lbFin<CR><LF>    18.78 lbFin of counter-clockwise torque
4.285 Nm<CR><LF>       4.285 Nm of clockwise torque
```

The number of digits after the decimal point is dependent of the tester's capacity and resolution.

Polarity may be inverted or omitted, as shown in the table above.

Any detected errors are reported back by means of error code *10 (illegal command).

12.2 Mitutoyo BCD settings

This output is useful for connection to data collectors, printers, multiplexers, or any other device capable of accepting Mitutoyo BCD data. Individual data points may be transmitted by pressing **DATA** or by requesting it from the Mitutoyo communication device (if available). To enable Mitutoyo output, select the desired format – either with polarity or without polarity. The display appears as follows:



12.3 Analog Output

This output can be used for chart recorders, oscilloscopes, data acquisition systems, or any other compatible devices with analog inputs. The output produces ± 1 volt at full scale of the instrument. The polarity of the signal is positive for clockwise and negative for counter-clockwise.

12.4 DATA Key Settings

To configure the functions of the **DATA** key, select **DATA Key** from the menu. The display appears as follows:

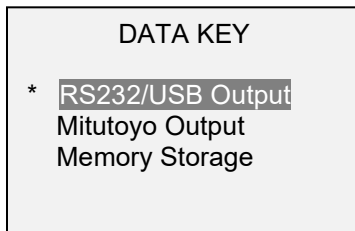

RS232/USB Output	Outputs data via the serial and USB ports
Mitutoyo Output	Outputs data via Mitutoyo (Digimatic) through the serial port
Memory Storage	Stores a reading to memory (refer to the Memory section for details)

Any combination of the above functions may be selected.

12.5 I/O Connector Pin Diagram (DB-15HD female)

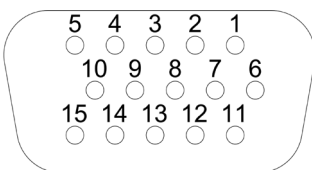

Pin No.	Description	Input / Output
1	Signal Ground	---
2	Counter-clockwise Overload	Output
3	RS-232 Receive	Input
4	RS-232 Transmit	Output
5	+12V DC	Input/Output
6	Analog Output	Output
7	Clockwise Overload	Output
8	Mitutoyo Clock Output Bit 2	Output
9	Mitutoyo Data Output Bit 0	Output
10	Mitutoyo Request Input Bit 3	Input
11 *	Set Point Pin 1 *	Output *
12 *	Set Point Pin 2 *	Output *
13 *	Set Point Pin 3 *	Output *
14	Do not connect	---
15	Mitutoyo Ready Output Bit 1	Output

* The output assignments depend on several factors described in the table below. Output functions always reference the primary reading on the display, regardless of the current mode.

Torque	Pin 11	Pin 12	Pin 13
Upper and Lower Set Points are Clockwise			
Greater than or equal to upper set point	On	Off	Off
Between upper and lower set points	Off	Off	On
Less than or equal to lower set point	Off	On	Off
Upper and Lower Set Points are Counter-clockwise			
Greater than or equal to upper set point	Off	On	Off
Between upper and lower set points	Off	Off	On
Less than or equal to lower set point	On	Off	Off
Upper Set Point is Clockwise, Lower Set Point is Counter-clockwise			
Greater than or equal to upper set point, in clockwise	Off	On	Off
Between upper and lower set points	Off	Off	On
Greater than or equal to lower set point, in counter-clockwise	On	Off	Off
Upper Set Point is Counter-clockwise, Lower Set Point is Clockwise			
Greater than or equal to upper set point, in counter-clockwise	Off	On	Off
Between upper and lower set points	Off	Off	On
Greater than or equal to lower set point, in clockwise	On	Off	Off

13 CALIBRATION



13.1 Initial Physical Setup

The TT01 should be mounted to a fixture rugged enough to withstand a load equal to the full capacity of the tester. Suitable calibration equipment is required, and caution should be taken while handling such equipment. The AC1036 calibration kit is available from Mark-10, shown at left.



Note the circular groove in the top plate, shown at right, which accommodates a cable for suspension of deadweights. The AC1036 calibration kit includes a cable with a diameter of 0.063 in [1.6 mm] for insertion into this groove. The cable radius plus the circular groove radius is equal to 3.333 in [84.66 mm]. Commonly available Imperial deadweights may, therefore, be employed to achieve full scale Imperial (i.e. lbFin) loads. For example, a 15 lb load multiplied by 3.333 in. will produce 50 lbFin of torque.

Metric unit calibrations are also possible through the configurable calibration procedure described below:

13.2 Calibration Procedure

1. Select **Calibration** from the menu. The display appears as follows:

```

CALIBRATION

To invert the
display, press the
DIRECTION button,
then press ENTER.
  
```

2. Press **DIRECTION** to invert the display, if desired. **ENTER** to continue. The display appears as follows:

```

CALIBRATION
Enter # cal points
(1 to 10)
Clockwise:
  5
Counter-clockwise:
  5
  
```

The tester can be calibrated at up to 10 points in each direction. Enter the number of calibration points for each direction (clockwise and counter-clockwise). At least one point must be selected for each direction.

Note: To achieve the accuracy specification of $\pm 0.3\%$, it is recommended to calibrate the tester at 5 or more even increments in both directions. For example, an MTT01-50 should be calibrated at 10, 20, 30, 40, and 50 lbFin loads in each direction.

3. To escape the **Calibration** menu at any time, press **ESCAPE**. The display appears as follows:

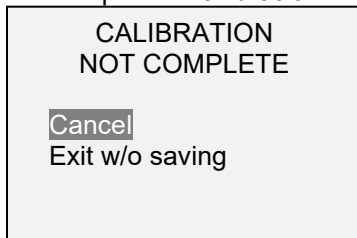

Selecting “Cancel” will revert back to the Calibration setup. Selecting “Exit w/o saving” will return to the menu without saving changes.

4. After the number of calibration points has been entered, press **ENTER**. The display appears as follows:



5. Place the tester on a level surface free from vibration, then press **ZERO**. The tester will calculate internal offsets, and the display appears as follows:

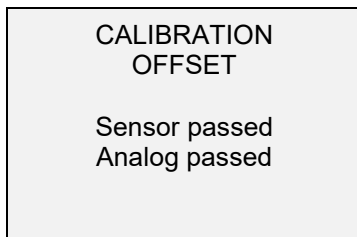

If failed:

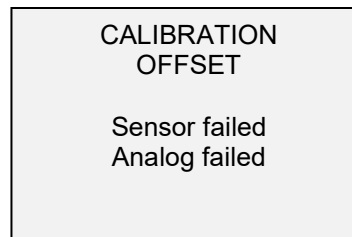

6. The following screen appears after the offsets have been calculated:



Attach weight fixtures (brackets, hooks, etc), as required. Do not yet attach any weights or apply any calibration loads. Press **ENTER**.

7. The display appears as follows:

```
CALIBRATION
CLOCKWISE

Optionally exercise
sensor, then press
ENTER.
```

Optionally exercise the torque sensor several times (at full scale, if possible), then press **ENTER**.

8. The display appears as follows:

```
CALIBRATION
CLOCKWISE
Gain adjust
Apply full scale load
50.00 lbFin +/-20%,
then press ENTER.
```

Apply a weight equal to the full scale of the instrument, then press **ENTER**.

9. After displaying "Please wait..." the display appears as follows:

```
CALIBRATION
CLOCKWISE

Ensure no load,
then press ZERO.
```

Remove the load applied in Step 8, leave the fixtures in place, then press **ZERO**.

10. The display appears as follows:

```
CALIBRATION
CLOCKWISE
Apply load
1 OF 5
Enter load:
10.00 lbFin
Press ENTER.
```

Use the **UP** and **DOWN** keys to adjust the load value as required. The load values default to even increments, as indicated by the previously entered number of data points (even increments are recommended for best results). For example, if a 50 lbFin capacity tester is calibrated, and 5 data points were selected, the load values will default to 10, 20, 30, 40, and 50 lbFin. Apply the calibration load. Then press **ENTER**.

Repeat the above step for the number of data points selected.

11. After all the clockwise calibration points have been completed, the display appears as follows:

CALIBRATION
CLOCKWISE COMPLETE
Reverse direction
for counter-clockwise.
Attach necessary
weight fixtures,
then press ENTER.

Press **ENTER**.

12. Attach weight fixtures. The following screens will step through the same procedure as with the compression direction. Proceed in the same manner.
13. At the completion of the tension calibration, the display appears as follows:

CALIBRATION
COMPLETE
Save & exit
Exit w/o saving

To save the calibration information, select "Save & exit". To exit without saving the data select "Exit without saving".

14. Any errors are reported by the following screens:

CALIBRATION
Units must be lbFin.
Please try again
Press ENTER.

Displayed at the start of calibration if a disallowed unit is selected.

CALIBRATION
Load not stable.
Please try again.

Ensure that the load is not swinging, oscillating, or vibrating in any manner. Then try again.

CALIBRATION
COMPRESSION
Load too low.
Please try again.

The calibration weight does not match the set value.

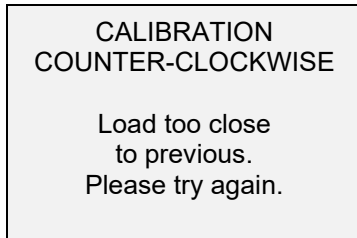

The entered calibration point is too close to the previous point.

14 PASSWORDS

Two separate passwords may be set to control access to the **Calibration** section and to the menu and other keys. To access the passwords setup screen, select **Passwords** from the menu. The display appears as follows:

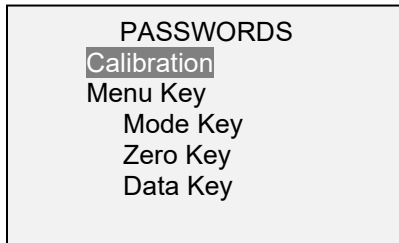

14.1 Calibration Password

Select **Calibration** from the sub-menu. The display appears as follows:

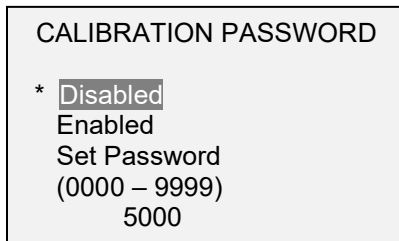

To set the password, select **Enabled**, then **Set Password**. Use the **UP** and **DOWN** keys to increment and decrement the value, from 0 to 9999. When the desired value has been selected, press **ENTER**, then **ESC** to exit the sub-menu.

14.2 Menu Key Password

If enabled, a password must be provided every time the **MENU** key is selected. Select **Menu Key** from the sub-menu. Follow the same procedure as described in the previous sub-section.

14.3 Locking Out Other Keys

Other keys may be locked out individually. Select any combination of keys (**MODE**, **ZERO**, **DATA**) by pressing **ENTER** in the **Passwords** sub-menu. Pressing a locked key will prompt the message "KEY PROTECTED" and then revert to the previous screen.

14.4 Password Prompts

If passwords have been enabled, the following will be displayed when pressing the **MENU** key or accessing the **Calibration** section:

ENTER PASSWORD
(0000 – 9999)

5000

Use the **UP** and **DOWN** keys to select the correct password, then press **ENTER** to continue.

If the incorrect password has been entered, the display appears as follows:

INCORRECT PASSWORD

Reset password
Request code:
XXXX

Press ENTER or ESC

To re-enter the password, press **ESC** to exit to the home screen. Then, access the desired function and enter the password again when prompted.

If the password has been misplaced, it can be reset. Press **ENTER** to generate a *request code*. The *request code* must be supplied to Mark-10 or a distributor, who will then provide a corresponding *activation code*. Enter the *activation code* to disable the password.

15 OTHER SETTINGS

15.1 Automatic Shutoff

The tester may be configured to automatically power off following a period of inactivity while on battery power. Inactivity is defined as the absence of any key presses or load changes of 100 counts or less. To access these settings, select **Automatic Shutoff** from the menu. The display appears as follows:

AUTOMATIC SHUTOFF

* Disabled

Enabled

Set Minutes

5

Select **Disabled** to disable automatic shutoff. Select **Enabled** to enable it. The length of time of inactivity is programmed in minutes via the **Set Minutes** parameter. Available settings: 5-30, in 5 minute increments.

Note: If the AC adapter is plugged in, the tester will ignore the **Automatic Shutoff** setting and remain powered on until the **POWER** key is pressed.

15.2 Backlight

Although the backlight may be turned on and off at any time by pressing the **BACKLIGHT** key, there are several available initial settings (applicable upon powering on the tester). To access these settings, select **Backlight** from the menu. The display appears as follows:



Selection	Description
Off	Backlight to be off upon powering on the tester.
On	Backlight to be on upon powering on the tester.
Auto	Backlight to be on upon powering tester, but will shut off after a period of inactivity (as defined in the Automatic Shutoff sub-section). The backlight will turn on again when activity resumes. The length of time of inactivity is programmed in minutes via the Set Minutes parameter. Available settings: 1-10, in 1 minute increments.

Note: If the AC adapter is plugged in, the tester will ignore these settings and keep the backlight on, unless the **BACKLIGHT** key is pressed. Selecting the **On** or **Off** setting in the **Backlight** menu will manually turn the backlight on or off as if the Backlight button were pressed.

15.3 LCD Contrast

The contrast of the display may be adjusted. Select **LCD Contrast** from the menu. The display appears as follows:



Press **ENTER** to modify the contrast. Select a value from 0 to 25, with 25 producing the most contrast.

15.4 Tones

Audible tones can be enabled for all key presses and alerts, such as overload, set point value reached, etc. The Set Point alert can be configured to be either a momentary tone or a continuous tone (until the load is restored to a value between the set points). To configure the functions for which audible tones will apply, select **Tones** from the menu. The display appears as follows:

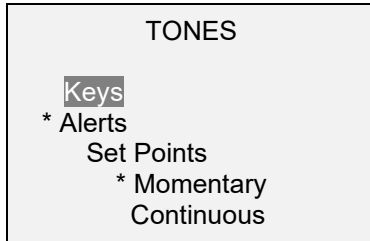

15.5 Initial Settings

The default units and operating mode at power-on may be configured. To access this parameter, select **Initial Settings** from the menu. The screen will display the available modes. An example is as follows:

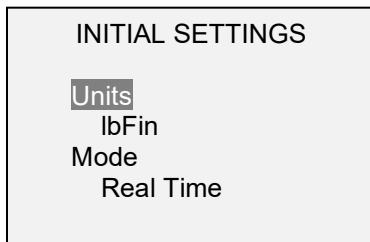

For available selections, refer to the **Units** and **Home Screen And Controls** sections.

15.6 Restore Default Settings

Default factory settings can be restored by selecting **Restore Defaults** from the menu. The settings may be found in the **Specifications** section. The display appears as follows:

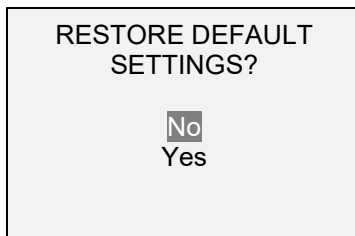

15.7 Information / Welcome Screen

The following screen is displayed at power-up and can be accessed at any time by selecting **Information**:

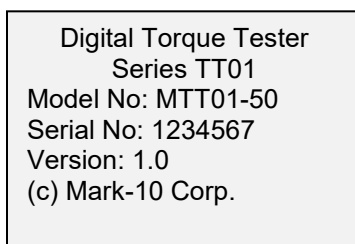

16 SPECIFICATIONS

16.1 General

Accuracy:	±0.3% of full scale
Sampling rate:	7,000 Hz
Power:	AC or rechargeable battery. Low battery indicator appears when battery level is low, and tester powers off automatically when power reaches critical stage.
Battery life:	Backlight on: up to 7 hours of continuous use / Backlight off: up to 24 hours of continuous use
Measurement units:	ozFin, lbFin, kgFcm, Nm, Ncm
Outputs:	USB / RS-232: Configurable up to 115,200 baud. Mitutoyo (Digimatic): Serial BCD suitable for all Mitutoyo SPC-compatible devices. Analog: ±1 VDC, ±0.25% of full scale at capacity. General purpose: Three open drain outputs, one input. Set points: Three open drain lines.
Safe overload:	150% of full scale (display shows "OVER" at 110% and above)
Weight:	8.4 lb [3.8 kg]
Included accessories:	Set of four posts, AC adapter, battery, USB cable, NIST-traceable certificate of calibration
Environmental requirements:	40 - 100°F, max. 93% humidity, non-condensating
Warranty:	3 years (see individual statement for further details)
Literature & Software:	Download at: www.mark-10.com/resources

16.2 Dimensions IN [MM]

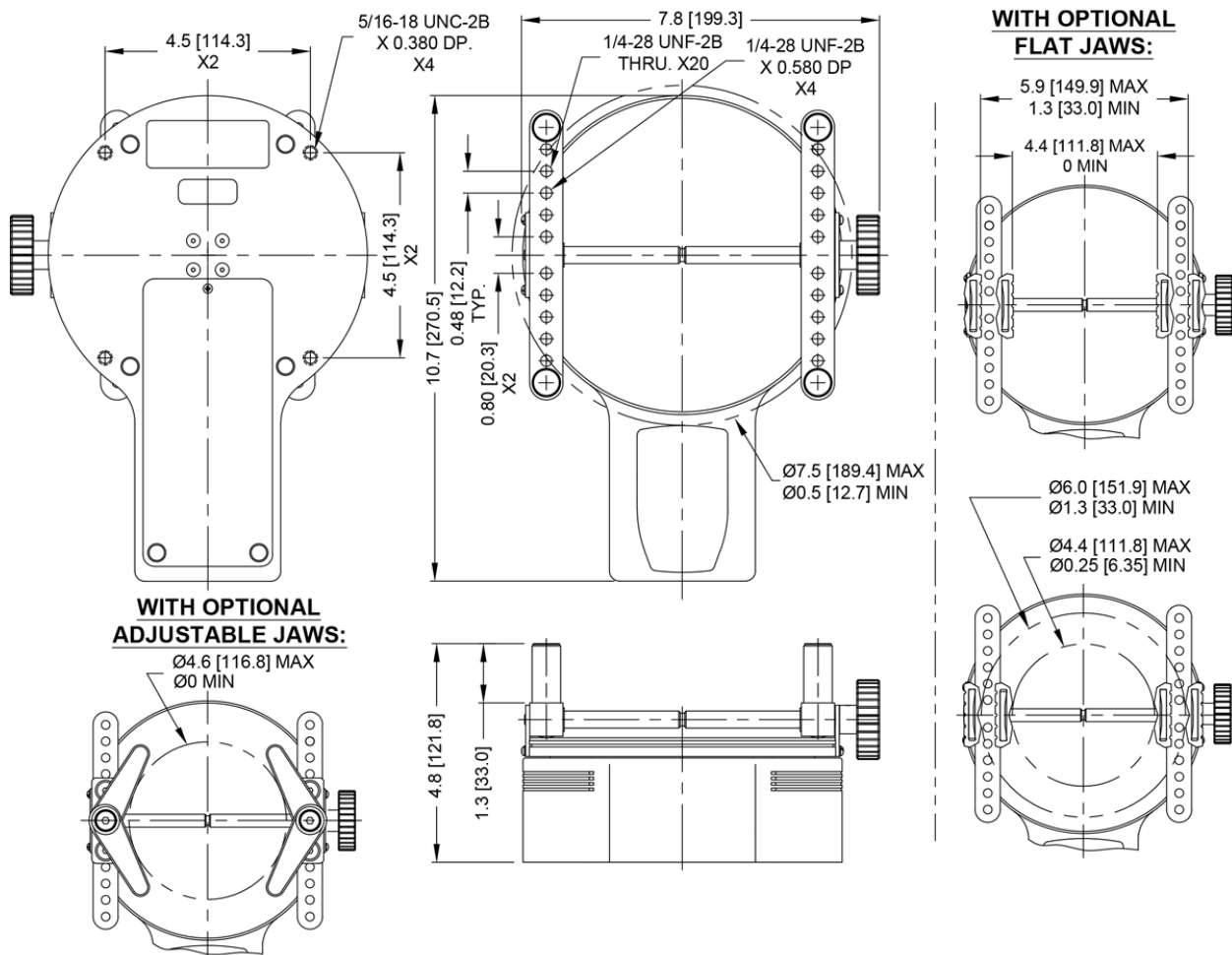

16.3 Factory Settings

Parameter	Setting
Set points	
Upper	Disabled (defaults to 80% of full scale, clockwise, when enabled)
Lower	Disabled (defaults to 40% of full scale, clockwise, when enabled)
Filters	
Current	8
Displayed	512
DATA Key Functions	
RS-232/USB Output	Enabled
Mitutoyo Output	Disabled
Memory Storage	Enabled
Serial/USB	
RS-232 Output Selected	Disabled
USB Output Selected	Enabled
Baud Rate	9,600
Data Format	Numeric + units
Mitutoyo BCD Output	Disabled
Break Detection	Disabled
Threshold	5% of full scale
% Drop	50% of peak
Auto Zero Delay	5 sec.
Auto Output Settings	All disabled
Auto Storage	Disabled
Auto Zero	Disabled
First, Second Peak	Disabled
Thresholds	10%
% Drops	50%
Auto Zero Delay	5 sec.
Auto Output Settings	All disabled
Auto Store Peaks	Disabled
Backlight	Auto
Minutes	1
Automatic Shutoff	Enabled
Minutes	5
Tones	
Keys	Enabled
Alerts	Enabled
Set Points	Momentary
Initial Mode	Real Time
Units	lbFin
Passwords	All passwords disabled

16.4 Capacity x Resolution

Model No.	lbFin	ozFin	kgFcm	Ncm	Nm
MTT01-12	12 x 0.005	192 x 0.1	14 x 0.01	135 x 0.1	1.35 x 0.001
MTT01-25	25 x 0.01	400 x 0.2	28 x 0.02	290 x 0.2	2.9 x 0.002
MTT01-50	50 x 0.02	800 x 0.5	58 x 0.05	570 x 0.5	5.7 x 0.005
MTT01-100	100 x 0.05	1600 x 1	116 x 0.1	1150 x 0.5	11.5 x 0.005



Mark-10 Corporation has been an innovator in the force and torque measurement fields since 1979. We strive to achieve 100% customer satisfaction through excellence in product design, manufacturing and customer support. In addition to our standard line of products we can provide modifications and custom designs for OEM applications. Our engineering team is eager to satisfy any special requirements. Please contact us for further information or suggestions for improvement.



Force and torque measurement engineered better

Mark-10 Corporation

11 Dixon Avenue
Copiague, NY 11726 USA
1-888-MARK-TEN
Tel: 631-842-9200
Fax: 631-842-9201
Internet: www.mark-10.com
E-mail: info@mark-10.com